

Aesculap Instruments for tunnel technique

To cover periodontal recessions



Aesculap Dental

Instruments for tunnel technique



Rounded plate-shaped working tips allow more movement and significantly increase the radius of mobilisation in frontal and lateral sub-periosteal preparation.

The sharpened edge of the instrument tips also allows sulcular as well as tunnel technique preparation (as with the envelope technique).



The design and angle of the working tips significantly facilitates preparation in convex areas.

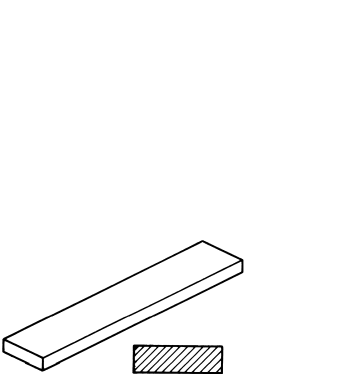
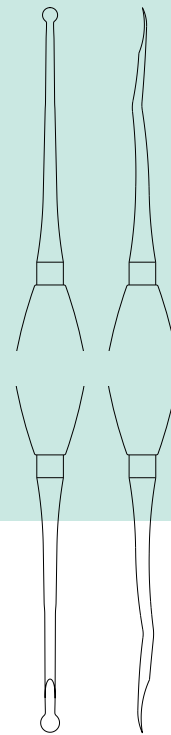

DB095

Original Arkansas grinding stone for grinding on tunnelling instruments
75 x 25 x 7 mm



JG598

Sterilit® Aesculap oil for grinding stones
Contents: 50 ccm



STRICKER
DX310R

195 mm, 7³/₄"

The **straight** tunnelling instrument is mainly used in the upper jaw, in the frontal and lateral region. This allows large areas of the gingiva to be undermined using both tunnel and sulcular techniques.

for periodontal recessions

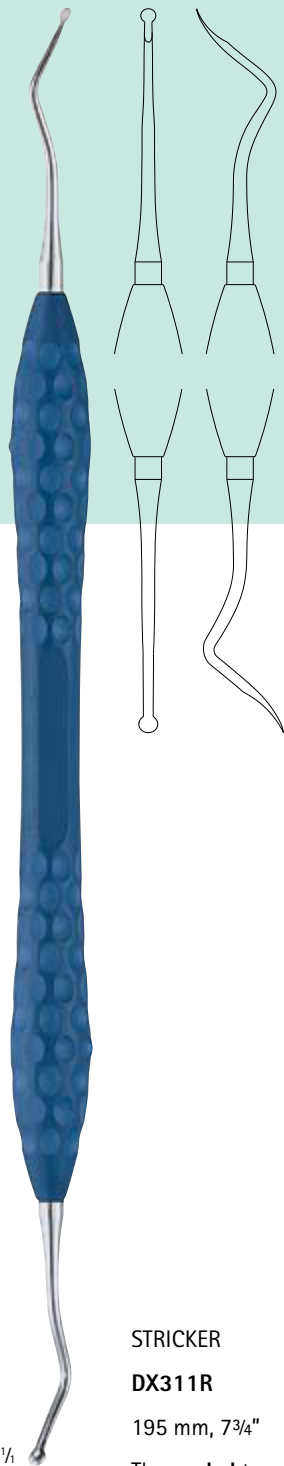

**STRICKER
DX311R**
195 mm, 7³/₄"

The **angled** tunnelling instrument is primarily used for preparing lateral, buccal regions. It can also be used distally, without tearing the mucosal tissue and also for the lower jaw.

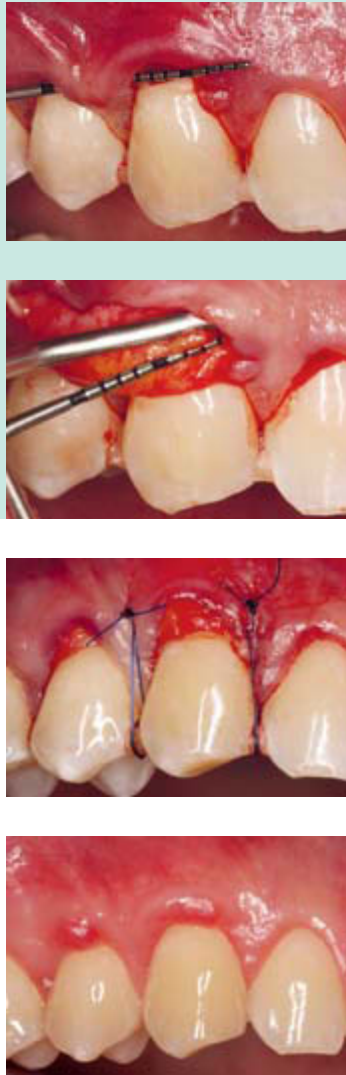

BB045T
145 mm, 5³/₄"

Titanium scalpel handle for micro-surgery blades, round handle. Light, rotatable and handy for precise cutting



**ERGOPLANT
DX305R**
150 mm, 6"

Microblade holder with round handle, for precision incisions



BB367R

Microsurgery blade sterile packed
Sales unit:
PAK = Package of 10 pieces



BB369R

Microsurgical blade stainless steel, sterile packed
Sales unit: **ST** = package of 1 piece



BB063R

145 mm, 5³/₄"

Scalpel handle for sterile scalpel blades



BB511

Fig. 11

BB515

Fig. 15

BB515-C

Fig. 15-C

Sterile scalpel blade,
vacuum heat treated,
sterile packed
Sales unit: **PAK** =
package of 100 pieces



BM003R

180 mm, 7"

DUROGRIP® Needle holder
for suture material 4/0 - 6/0

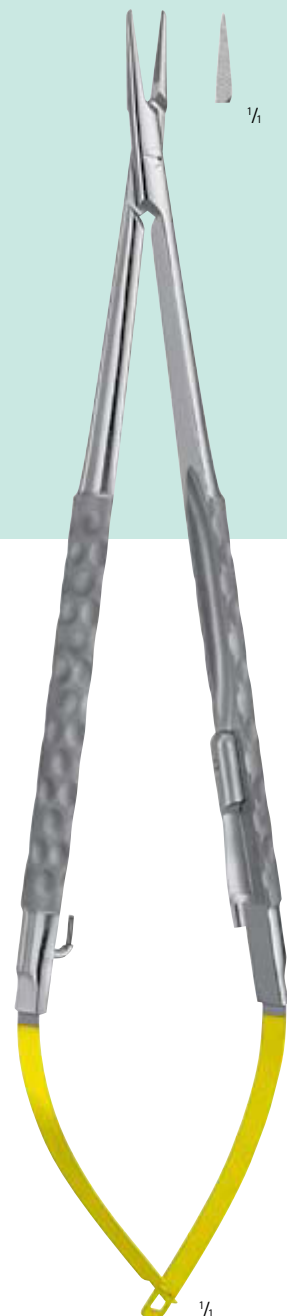

FD258R

180 mm, 7"

DIADUST® needle holder
with carbide inserts for
suture material 6/0 - 8/0

for periodontal recessions

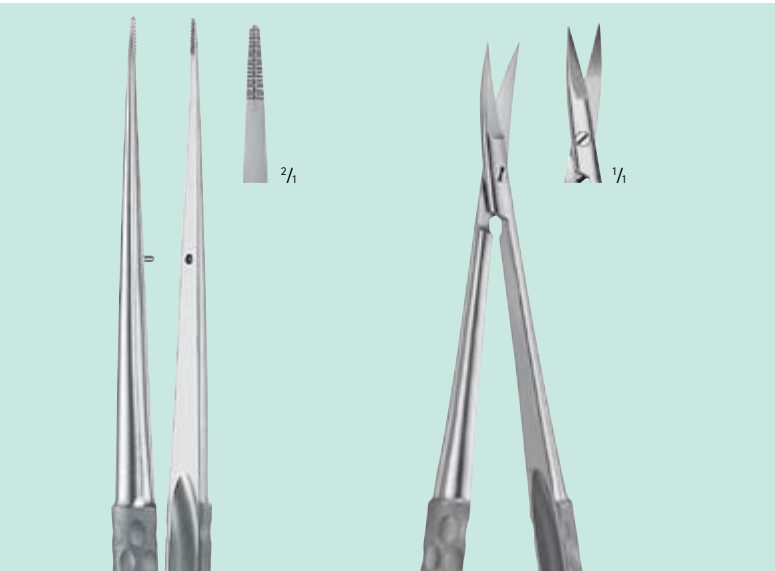

**COOLEY
DX303R**
180 mm, 7"
Atraumatic
micro forceps

FD252R
180 mm, 7"
Micro ligature scissors, curved,
one blade serrated



JG381R
274 x 172 x 30 mm
Tray, including 3 x JG391
silicone bars, suitable for
dental container JN092

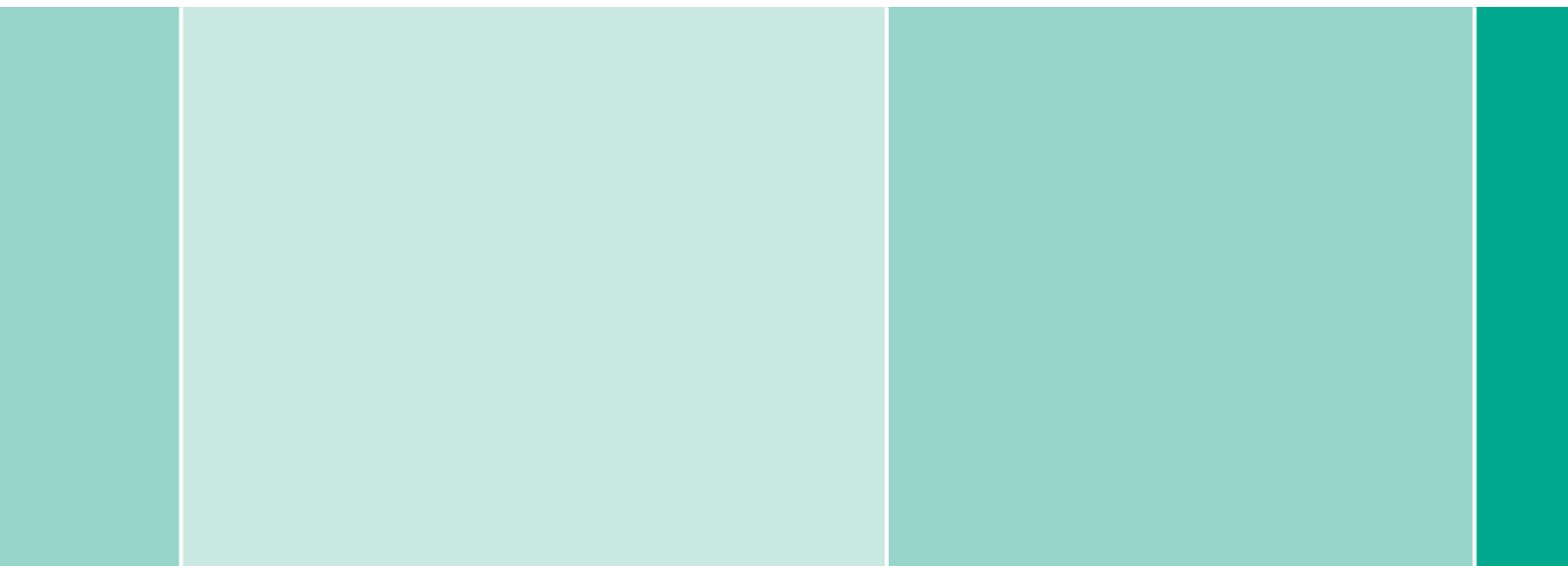

Aesculap AG | Am Aesculap-Platz | 78532 Tuttlingen | Germany
Phone +49 7461 95-0 | Fax +49 7461 95-26 00 | www.aesculap-dental.com

Aesculap – a B. Braun company

The main product trademark 'Aesculap' and the product trademarks 'Sterilit', 'DIADUST' and 'DUROGRIP' are registered trademarks of Aesculap AG.

Subject to technical changes. All rights reserved. This brochure may only be used for the exclusive purpose of obtaining information about our products. Reproduction in any form partial or otherwise is not permitted.

Brochure No. D12102

0214/0.25/2